

<u>Contents</u>	<u>page</u>
Safety Precaution	2
Important safeguards	2
Looking after your Micro H <sub>2</sub> meter	2
Introduction	2
Before you begin Micro H <sub>2</sub> meter system Overview	3
H <sub>2</sub> sensor	4
Micro H <sub>2</sub> meter exploded view	5
Disassembling the Micro H <sub>2</sub> meter for servicing	6
Replacing the service Parts of the Micro H <sub>2</sub>	6
Reassembling the Micro H <sub>2</sub> meter	7
Calibrating the Micro H <sub>2</sub> meter	8
Circuit description	9
Specifications	12
Technical support	13
Parts List	14
Circuit Diagram	17

# Micro H<sub>2</sub> Meter

## Service Manual

044-11 Iss. 1.1 September 1998

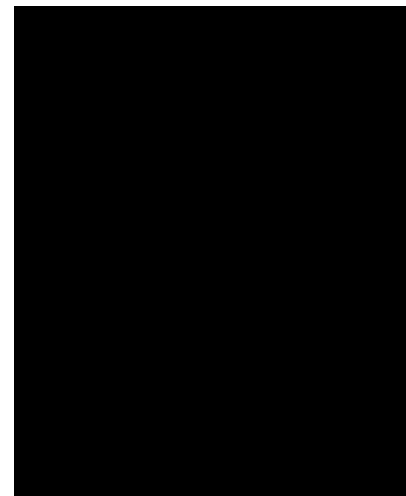

# Micro H<sub>2</sub> Meter

# Service Manual

---

Information in this document is subject to change without notice and does not represent a commitment on the part of Micro Medical Limited. Only the parts supplied by Micro Medical Limited should be used to complete the service operation described in this manual. If in any way you feel unsure about the successful completion of the service operation you should contact Micro Medical Limited or its appointed agent in your country or region and arrange the despatch of the product to a Micro Medical Limited Service Centre.

Copyright 1998 by Micro Medical Limited All rights reserved

Drawing no. 044-11

Version 1.1

September 1998

All other products are trademarks or registered trademarks of their respective owners.

---

## **Safety Precaution**

The servicing of this device is intended to be carried out by a properly trained and competent electronics engineer, or experienced in the maintenance and servicing of medical devices. Read this manual thoroughly before proceeding with the service. If in any doubt please contact the service centre at Micro Medical Limited or their accredited agent in your country or region.

---

## **Important Safeguards**

- o Read all of the instructions.
- o Keep the instructions in a safe place for later use.
- o Follow all warnings and instructions marked on the product.
- o When replacement parts are required, be sure to use replacement parts specified by Micro Medical that have the same characteristics as the original parts. Unauthorised substitutions may result in fire, electric or other hazards.
- o Do not place on an unstable table.
- o The product should be operated only from the type of power source indicated on the label.

---

## **Looking after your Micro H<sub>2</sub> Meter**

- o Avoid exposing the Micro H<sub>2</sub> Meter to direct sunlight.
- o Avoid operating the Micro H<sub>2</sub> Meter in dusty conditions or near to heating appliances or radiators.
- o Do not keep the Micro H<sub>2</sub> Meter in a damp place or expose it to extreme temperatures.

---

## **Introduction**

This service manual provides you with information to carry out the servicing of the Micro H<sub>2</sub> Meter. It is a process, which is relatively straightforward but must be carried out in a logical sequence. Our advice is to familiarise yourself with the contents of this manual before attempting to carry out the procedure of replacing the parts supplied in the sensor replacement kit for the Micro H<sub>2</sub> Meter.

---

## **Before You Begin**

Before you begin the servicing operation, please read the section on Circuit description very carefully:

---

## Micro H<sub>2</sub> Meter system overview.

The Micro Medical Micro H<sub>2</sub> meter consists of a hand held microcomputer unit (1) incorporating a H<sub>2</sub> sensor and is supplied with a mouthpiece adapter with integral one way valve (2), face mask adapter (6), and disposable cardboard mouthpieces (5).

The microcomputer unit is powered by a single alkaline PP3 battery (4) and is supplied with a reducing connector for calibration (3).

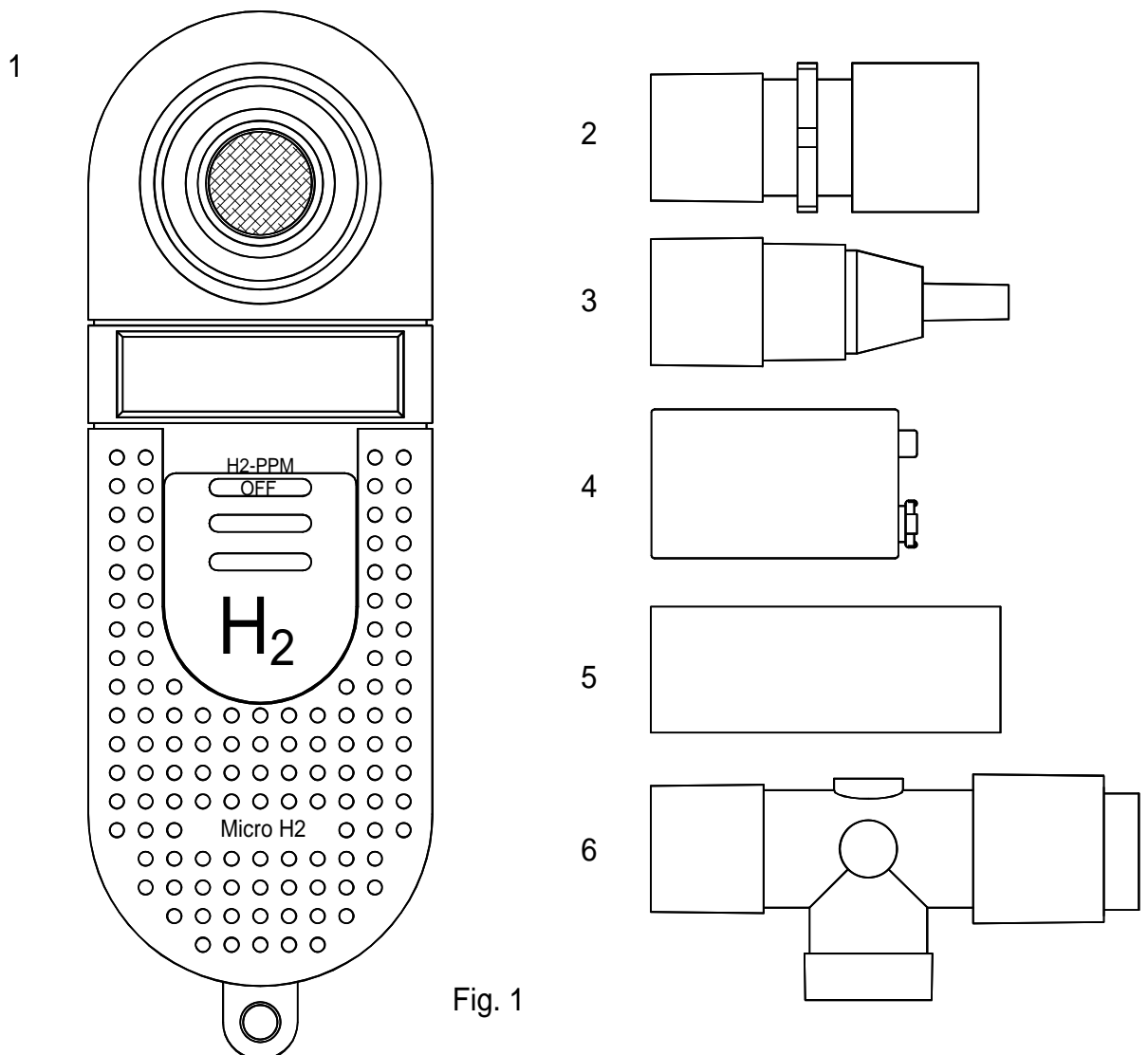

Fig. 1

The H<sub>2</sub> sensor is an electrochemical fuel cell type 7HYT supplied by City Technology Ltd. It works through the reaction of hydrogen at one electrode and oxygen (from ambient air) at the other. This reaction generates an electrical current proportional to the concentration of H<sub>2</sub> exposed to the sensing surface of the fuel cell.

The subject breathes onto the sensor through the mouthpiece connected mouthpiece adapter or through a face-mask if the subject is an infant. The instrument then displays the peak value obtained in parts per million (ppm).

The Micro H<sub>2</sub> is used in the diagnosis of lactose mal-absorption, a condition which produces increased hydrogen levels in the blood when un-absorbed lactose reacts with bacteria in the intestines. This increased level of hydrogen is expired and can be measured after ingestion of lactose following a period of fasting.

---

## H<sub>2</sub> Sensor

The sensor is an electrochemical micro fuel cell using gaseous diffusion barrier technology resulting in a direct response to volume concentration rather than partial pressure as with other fuel cells.

The fuel cell uses a three electrode design, which gives increased selectivity to the measured gas compared with two electrode designs. The three electrode cell consists of a sensing electrode, a counter electrode and a reference electrode separated by a thin layer of electrolyte. The gaseous diffusion barrier limits the flow of gas to the sensing electrode and ensures the electrochemical activity of the electrode is far in excess of the amount of gas with which it has to deal.

Gas diffusing onto the sensing electrode reacts at the surface of the electrode by oxidation.

H<sub>2</sub> reacts at the sensing electrode according to the equation:

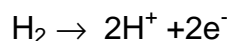

The counter electrode acts to balance out the reaction at the sensing electrode by reducing oxygen in air to water:

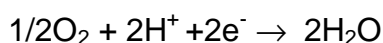

A low power circuit powered by an internal 950 mA-hr lithium battery is used to maintain the fuel cell in a permanently active state to produce a zero start up time.

The battery has an operational life greater than the life of the electrochemical fuel cell.

# Micro H<sub>2</sub> meter exploded view

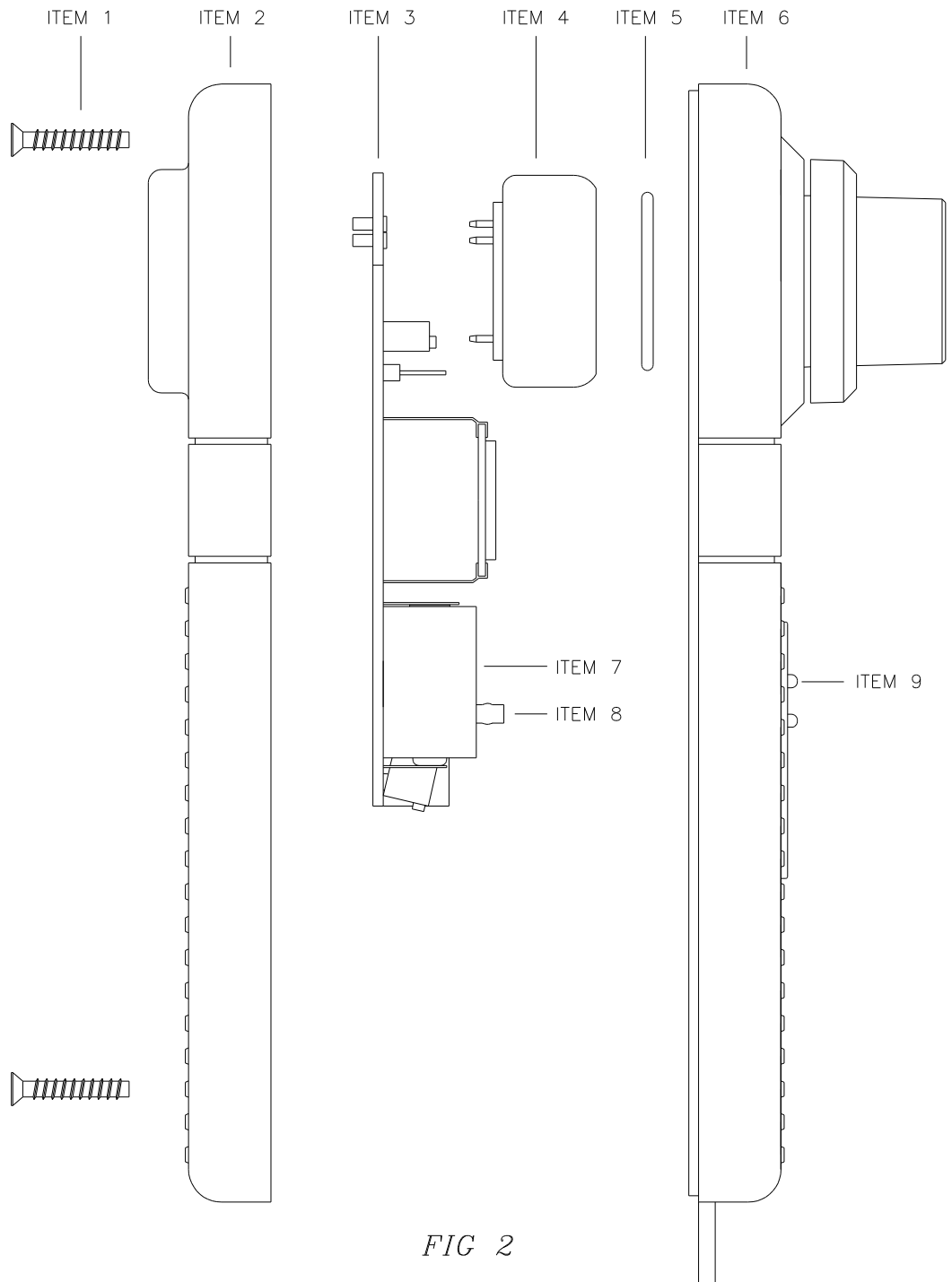

FIG 2

---

## Disassembling the Micro H<sub>2</sub> meter for servicing.

The Micro H<sub>2</sub> microcontroller unit comprises of a solid state electronic circuit in a robust ABS housing and does not require any preventative maintenance.

Routine maintenance consists of replacing the fuel cell and internal lithium battery when they are exhausted. The 3.6 volt lithium battery is continuously monitored by the microcontroller and the message **CEL** will be displayed when the voltage falls below 3 volts. When this happens replace both the fuel cell and the lithium battery by following the procedure below.

1. Turn the unit face down and slide back the battery compartment.
2. Remove the PP3 battery.
3. Remove the 2 self tapping screws (Item 1) and put to one side.
4. Lift the top moulding (Item 6) from the bottom moulding (Item 2).
5. Remove the PCB (Item 3) from the bottom moulding.
6. Carefully remove the fuel cell (Item 4) and disregard.
7. Unsolder the lithium battery (Item 7) from the PCB and disregard.

---

## Replacing the Service parts of the Micro H<sub>2</sub>

1. Solder the new battery in place (Cat No: BAT3700) **(Take great care not to short circuit the terminations even momentarily as the low internal impedance of lithium batteries will result in a high current consumption and greatly reduced life).**
2. Remove the H<sub>2</sub> (Cat No: CEL4400) sensor from the plastic container.
3. Remove the wire shorting link from the reference and shorting pins and carefully insert the H<sub>2</sub> cell into the PCB. **(Note: The fuel cell must not be left for more than a few minutes without the shorting link before inserting into the PCB or damage to the cell may result).**
4. The assembled PCB must now be left for two weeks to allow the fuel cell to stabilise at the bias voltage of 220mV.

---

## Reassembling the Micro H<sub>2</sub> meter

1. Place the PCB into the bottom moulding.
2. Ensure that the slide switch (Item 8) and the switch plate (Item 9) are both positioned at the bottom of their travel.
3. Ensure that the O.ring (Item 5) supplied with the fuel cell is in place.
4. Place the top moulding on top of the bottom moulding and secure using the two self-tapping screws.
5. Reconnect the PP3 battery ensuring correct polarity.



---

## Calibrating the H<sub>2</sub> meter

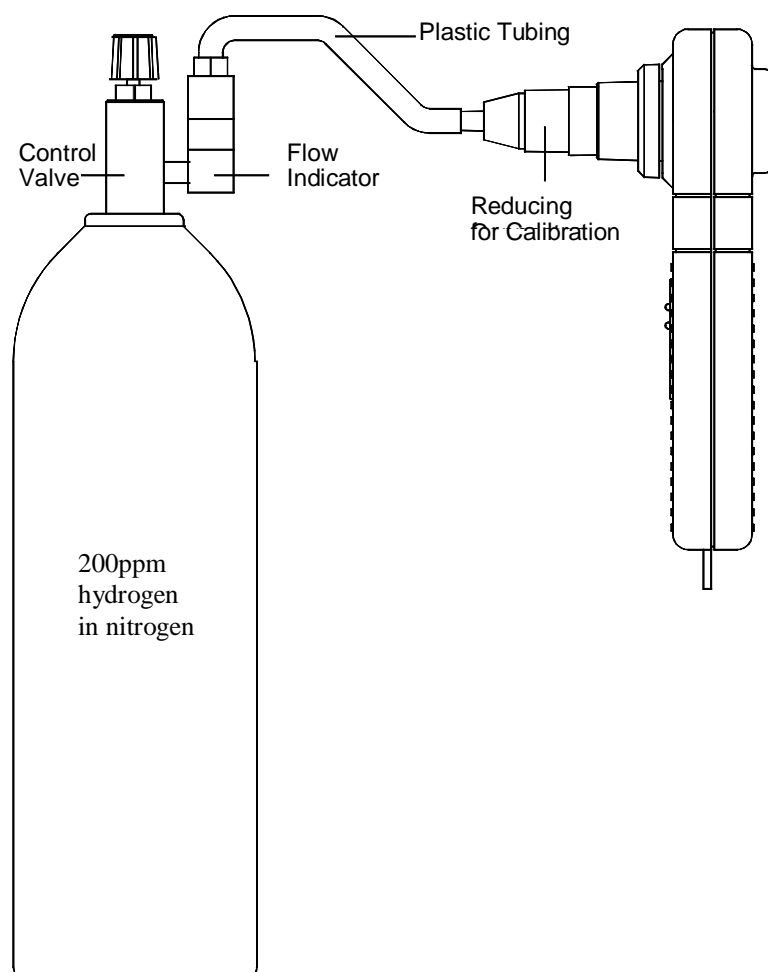

1. Setup the calibration equipment as shown above.
2. Locate the calibration potentiometer positioned in the battery compartment by moving the battery without disconnection.
3. Slide the switch on the Micro H<sub>2</sub> meter to the H<sub>2</sub>-PPM position and wait for the display to read zero
4. Supply a flow of Hydrogen in Nitrogen at a rate of approximately 0.25 l/min for 70 seconds and then turn off the supply.
5. Wait until the reading on the LCD display has stabilised.
6. Adjust the potentiometer so that the reading on the LCD display is the same as the measured reading on the gas bottle.
7. The unit is now ready for operation.

---

## Circuit description

(Refer to parts list, and to circuit diagram 037-20)

The circuit is based on the Motorola one time programmable (OTP) microcontroller MC68HC705C9ACP (IC1) operating at a clock frequency of 1 MHz.

This processor contains 7 Kbytes of EPROM, 176 Bytes of RAM, programmable output latches, and a serial peripheral interface (SPI). The current output signal from the sensor is conditioned using a current to voltage converter and is applied to a 8 channel analogue to digital (A/D) converter connected to a microprocessor. The calibration potentiometer is also connected to the A/D converter.

When the unit is first switched on the microprocessor records the baseline reading from the A/D and uses this value to auto-zero the instrument. The signal from the H<sub>2</sub> sensor and the voltage from the calibration potentiometer are both continuously monitored and the peak of the calculated hydrogen concentration is displayed.

---

## Power Supply

The unit has two separate supplies. The externally accessible alkaline 9 volt PP3 battery (BAT 1) provides the main supply. The instrument may be switched on and off with the slide switch and may also be switched off by a signal from the processor. This is done if the unit is left on, without use, for a period of 5 minutes in order to conserve battery power. The supply is controlled by gates A and B of IC2, arranged in a bi-stable configuration, and powered continuously from BAT1. When the slide switch is moved to the 'H<sub>2</sub>-PPM' position one end of R23 is pulled low. This transition is differentiated by the action of C12 and R22 so that a momentary pulse appears on pin 9 of IC3. This pulse will toggle the bi-stable circuit so that pin 11 will go low, turning transistor TR3 on, and supplying 9 volts to the low drop-out regulator, IC4. When the slide switch is returned to the 'off' position pin 13 of IC3 is pulled low, the bi-stable action is reversed, and TR4 will be turned off. If the unit is left on without use for 6 minutes then pin 30 of IC1 is driven high, under software control, turning on TR1 which will also turn the unit off via the bi-stable circuit. When this happens the slide switch must be pushed to the 'off' and then to the 'H<sub>2</sub>-PPM' position in order to initiate another pulse through C12 to turn the unit back on again. The output of the 5 volt regulator supplies the processor and associated circuitry. C1 and C2 smooth the input and output of IC4 respectively.

The secondary power supply is provided by a single 3.6 volt lithium cell used to permanently power the fuel cell conditioning circuit consisting of the op-amps (IC5 and IC6), and the precision voltage reference (ZD1) together with the associated passive circuitry. The conditioning circuit draws less than 72uA from the 950 mA-Hr lithium battery giving an operational life of 18 months.

---

## Fuel cell conditioning circuit

For correct operation the reference electrode of the fuel cell must be held at a constant bias voltage with respect to the sensing electrode (0 Volts). This is achieved by applying a voltage to the counter electrode to induce the correct bias voltage.

The output of IC5 is applied to the counter electrode through R1 and the inverting input is connected to the reference electrode through R2 and R3. The negative feedback action of this circuit ensures that the counter electrode is held at whatever potential is required (nominally 56mV) to keep the reference electrode at 0 volts with respect to the sensing electrode. The sensing electrode is held at ground potential by R6 to ground, and R5, which is connected to the virtual earth point of IC6. IC6, together with the associated passive components, forms a filtered current to voltage converter with a transfer factor of -47 mV/uA and a roll-off frequency of 3.4 Hz. R29 is connected from the inverting terminal of IC6 to the -1.26 volt supply. This produces a positive bias on the output of approximately 20mV. The sensitivity of the H<sub>2</sub> fuel cell is -0.03 +/- 0.01 uA producing a nominal 1.4 mV/ppm H<sub>2</sub> at the output of IC6.

The output of IC6 is filtered at 6.5 Hz by R9 and C11 and applied to the input of IC3(B). IC3(B) is in a non-inverting amplifier configuration with a gain of 4 giving 5.6mV/ppm H<sub>2</sub> at its output.

The output of IC3(B) is connected to channel 0 of the A/D converter.

---

## A/D converter

The A/D converter is a 10 bit, 8 channel, serial interface, low powered device with an integral voltage reference of 4.096 volts.

Channel 0 is used to monitor the output of the fuel cell.

Channel 1 monitors the lithium battery (BAT2) from the output of the buffer amplifier IC3(A). R16, between BAT2 and the inverting amplifier, prevents the battery from discharging through the op-amp when the supply is switched off. The battery has an end point of 3 volts and when this level is reached the message CEL will be displayed. When this happens follow the procedure outlined in **Servicing**.

Channel 2 measures the setting on the calibration potentiometer (VR2) which can be adjusted between 0 volts and Vref.

Channel 3 is used to monitor the PP3 battery (BAT1) through the potential divider, R13 and R14. When this battery falls below 6.6 volts a battery low warning is temporarily indicated on the display upon switch on. When the battery falls below 6.1 volts the message is displayed permanently and the unit cannot be used.

---

## **Reset Circuit**

This consists of the dedicated reset controller IC7. This device holds the reset low whilst the supply voltage is below 4.5 volts and takes the reset high after a period of 350msec once the supply has stabilised.

---

## **Display**

The display is a custom 3½ digit low power LCD. The seven segments of the three digits, the decimal point, the backplane and the blow legend are driven directly by ports A,B and C of the microprocessor. The backplane is driven by a square wave of nominally 60Hz. The individual segments are driven by a similar square wave, which is in phase with the backplane when the segment is off and 180 degrees out of phase when the segment is on.

---

## **Sounder**

The sounder is operated by a 1kHz square wave generated by pin 35 of IC1. One connection of the sounder is driven directly by pin 35 and the other by the inverted signal from TR1. This push-pull arrangement raises the driving voltage to the sounder and increases the volume

---

## Specifications

<b>Type</b>	Micro fuel cell
<b>Range</b>	0 – 500ppm
<b>Resolution</b>	1ppm
<b>Accuracy</b>	+/-5% of full scale or 1ppm whichever is greater
<b>Sensor Life</b>	>18 months
<b>Response time</b>	<70 sec (to 90% of reading)
<b>Operating temperature</b>	0 to 40°C
<b>Operating humidity</b>	30 – 90% continuous (0-99% intermittent)
<b>Operating pressure</b>	atmospheric +/-10%
<b>Pressure coefficient</b>	0.02% signal per mBar
<b>Baseline drift</b>	0ppm (auto zero)
<b>Long term drift</b>	<2% signal loss per month
<b>Power source</b>	Single Alkaline 9 volt PP3
<b>Battery life</b>	>30 hours of continuous use
<b>Weight</b>	160g
<b>Dimensions</b>	170 x 60 x 26mm
<b>Display</b>	3½ digit LCD
<b>Storage temperature</b>	-20°C to +70°C
<b>Storage humidity</b>	30% to 90%

---

## Technical Support

### Great Britain and World Headquarters

Micro Medical Ltd

PO Box 6

Rochester

Kent ME1 2AZ

Telephone + 44 (0)1634 360044

Fax +44 (0)1634 360055

Web Site <http://www.micromedical.com.uk>

Email [support@micromedical.com.uk](mailto:support@micromedical.com.uk)

**Contact Micro Medical Ltd for the local agent in your region or country for local service:**

## Parts List

Designation	Description
IC1	<b>(MC68HC705C9ACP)</b> MOTOROLA OTP MICROCONTROLLER
IC2	<b>(4093)</b> QUAD 2 INPUT NAND GATE
IC3	<b>(TL27L2CP)</b> DUAL LOW POWER OP-AMP
IC4	<b>(LM2931AZ5)</b> LOW DROP OUT LOW POWER 5 VOLT REGULATOR
IC5	<b>(OP90GS)</b> PRECISION MICRO POWER OP-AMP
IC6	<b>OP90GS)</b> PRECISION MICRO POWER OP-AMP
IC7	<b>(DS1233-10)</b> DALLAS ECONO RESET
IC8	<b>(MAX186DCAP)</b> 12 BIT SSOP SERIAL D/A OR <b>(MAX192BCAP)</b> 10 BIT A/D
D1	<b>(1N4148)</b> GENERAL PURPOSE DIODE
D2	<b>(BAT42)</b> GENERAL PURPOSE SCHOTTKY DIODE
ZD1	<b>(TC04BCZM)</b> 1.26V BANDGAP REFERENCE
DISPLAY	<b>(LCD 016-03)</b> 3½ DIGIT CUSTOM DISPLAY
TR1	<b>(BC182LB)</b> NPN TRANSISTOR TO92(A) PACKAGE ALTERNATIVE <b>(BC182LC)</b>
TR2	<b>BC182LB)</b> NPN TRANSISTOR TO92(A) PACKAGE ALTERNATIVE <b>(BC182LC)</b>
TR3	<b>(ZTX751)</b> PNP TRANSISTOR E-LINE PACKAGE
R1	1K SURFACE MOUNT RESISTOR 0.125 WATT 5% SIZE 1206
R2	10K SURFACE MOUNT RESISTOR 0.125 WATT 5% SIZE 1206
R3	10K SURFACE MOUNT RESISTOR 0.125 WATT 5% SIZE 1206
R4	47K SURFACE MOUNT RESISTOR 0.125 WATT 5% SIZE 1206
R5	10 OHM SURFACE MOUNT RESISTOR 0.125 WATT 5% SIZE 1206
R6	1K SURFACE MOUNT RESISTOR 0.125 WATT 5% SIZE 1206
R7	10K ¼WATT 5% RESISTOR
R8	3.3K ¼WATT 5% RESISTOR
R9	22K ¼WATT 5% RESISTOR
R10	100K SURFACE MOUNT RESISTOR 0.125 WATT 5% SIZE 1206
R11	10 OHM ¼WATT 5% RESISTOR
R12	4.7M ¼WATT 5% RESISTOR
R13	100K ¼WATT 5% RESISTOR
R14	100K ¼WATT 5% RESISTOR
R15	100K ¼WATT 5% RESISTOR
R16	1M SURFACE MOUNT RESISTOR 0.125 WATT 5% SIZE 1206
R17	100K SURFACE MOUNT RESISTOR 0.125 WATT 5% SIZE 1206
R18	ZERO OHM LINK
R19	NOT USED
R20	10K ¼WATT 5% RESISTOR
R21	1MEG ¼WATT 5% RESISTOR
R22	1MEG ¼WATT 5% RESISTOR
R23	1MEG ¼WATT 5% RESISTOR
R24	100K ¼WATT 5% RESISTOR
R25	10K ¼WATT 5% RESISTOR
R26	10K ¼WATT 5% RESISTOR
R27	10K ¼WATT 5% RESISTOR
R28	10K ¼WATT 5% RESISTOR
R29	1.8MEG SURFACE MOUNT RESISTOR 0.125 WATT 5% SIZE 1206
VR1	<b>(3266X-100K)</b> 100K MULTI TURN POTENTIOMETER
C1	47µF 16 VOLT ELECTROLYTIC CAPACITOR
C2	47µF 16 VOLT ELECTROLYTIC CAPACITOR
C3	47pF CERAMIC CAPACITOR
C4	47pF CERAMIC CAPACITOR
C5	47µF 16 VOLT ELECTROLYTIC CAPACITOR
C6	47µF 16 VOLT ELECTROLYTIC CAPACITOR
C7	0.1µF CERAMIC CAPACITOR

C8	1 $\mu$ F MULTILAYER CERAMIC CAPACITOR
C9	0.1 $\mu$ F CERAMIC CAPACITOR
C10	47 $\mu$ F 16 VOLT ELECTROLYTIC CAPACITOR
C11	47 $\mu$ F 16 VOLT ELECTROLYTIC CAPACITOR
C12	0.1 $\mu$ F CERAMIC CAPACITOR
C13	47 $\mu$ F 16 VOLT ELECTROLYTIC CAPACITOR
C14	0.1 $\mu$ F CERAMIC CAPACITOR
C15	100pF CERAMIC CAPACITOR
C16	1nF CERAMIC CAPACITOR
SW1	<b>(SLF2300)</b> DOUBL POLE 3 POSITION SLIDE SWITCH
BAT2	<b>(LS14250)</b> SAFT PCB MOUNTED 950mA-HOUR LITHIUM CELL
X1	4MHz CERAMIC RESONATOR



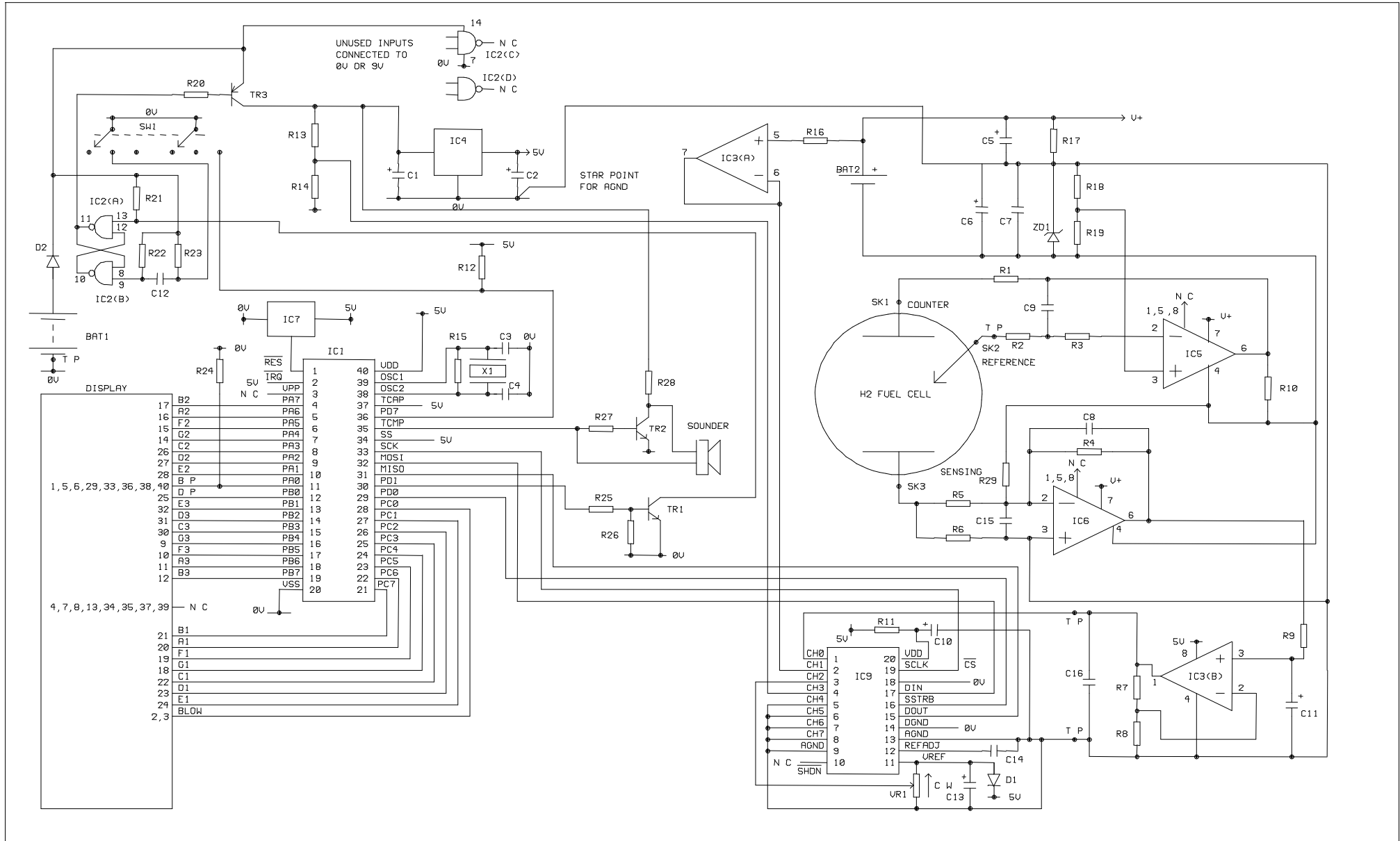

DRAWN C P L	TITLE	ISSUE	DATE	DESCRIPTION OF MOD	DATE	DESCRIPTION OF MOD
	MICRO H2 METER	1 1				
DATE 10/3/98	DRAWING No 044-09					